

Analog Multi Timer

MA4N

INSTRUCTION MANUAL

MAIN PRODUCTS

- DIGITAL : Temperature Controller, Counter, Timer, Speedmeter, Tachometer, Panel Meter, Recorder
- SENSOR : Proximity Sensor/Photo Electric Sensor, Rotary Encoder, Optical Fiber Sensor, Pressure Sensor
- ANALOG : Timer, Temperature Controller



We appreciate you for purchasing HanYoung NUX Co.,Ltd product. Before using the product you have purchased, check to make sure that it is exactly what you ordered. Then, please use it following the instructions below.

HEAD OFFICE

1381-3, Juan-Dong, Nam-Gu Incheon, Korea
TEL: (82-32)876-4697 FAX: (82-32)876-4696

■ Safety information

Before you use, read safety precautions carefully, and use this product properly. The precautions described in this manual contain important contents related with safety; therefore, please follow the instructions accordingly. The precautions are composed of DANGER, WARNING and CAUTION.

DANGER

There is a danger of occurring electric shock in the input/output terminals so please never let your body or conductive substance is touched.

WARNING

1. This product does not contain an electric switch or fuse, so the user needs to install a separate electric switch or fuse externally. (Fuse rating: 250V 0.5A)
2. To prevent deflection or malfunction of this product, supply proper power voltage in accordance with the rating.
3. To prevent electric shock or malfunction of product, do not supply the power until the wiring is completed.
4. Since this product is not designed with explosion-protective structure, do not use it any place with flammable or explosive gas.
5. Do not decompose, modify, revise or repair this product. This may be a cause of malfunction, electric shock or fire.
6. Reassemble this product while the power is OFF. Otherwise, it may be a cause of malfunction or electric shock.
7. If you use the product with methods other than specified by the manufacturer, there may be bodily injuries or property damages.
8. Due to the danger of electric shock, use this product installed onto a panel while an electric current is applied.

CAUTION

1. The contents of this manual may be changed without prior notification.
2. Before using the product you purchased, make sure that it is exactly what you ordered.
3. Make sure that there is no damage or abnormality of the product during delivery.
4. Do not use this product at any place with corrosive (especially noxious gas or ammonia) or flammable gas.
5. Do not use this product at any place with direct vibration or impact.
6. Do not use this product at any place with liquid, oil, medical substances, dust, salt or iron contents. (Use at Pollution level 1 or 2)
7. Do not polish this product with substances such as alcohol or benzene.
8. Do not use this product at any place with a large inductive difficulty or occurring static electricity or magnetic noise.
9. Do not use this product at any place with possible thermal accumulation due to direct sunlight or heat radiation.
10. Install this product at place under 2,000m in altitude.
11. When the product gets wet, the inspection is essential because there is a danger of electric leakage or fire.
12. If there is excessive noise from the power supply, using insulating transformer or noise filter is recommended. The noise filter must be attached to a panel which is already connected to a ground and the wire between the filter output and power supply terminal must be as short as possible.
13. If putting power cables closely together then it is effective against noise.
14. Do not connect anything to the unused terminals.
15. After checking the polarity of terminal, connect wires at the correct position.
16. When this product is connected to a panel, use a circuit breaker or switch approved with IEC947-1 or IEC947-3.
17. Install the circuit breaker or switch at near place for convenient use.
18. Write down on a label that if the circuit breaker or switch is operating then the power will be disconnected since the circuit breaker or switch is installed.
19. For the continuous and safe use of this product, the periodical maintenance is recommended.
20. Some parts of this product have limited life span, and others are changed by their usage.
21. The warranty period for this product including parts is one year if this product is properly used.

■ Names and functions of respective parts

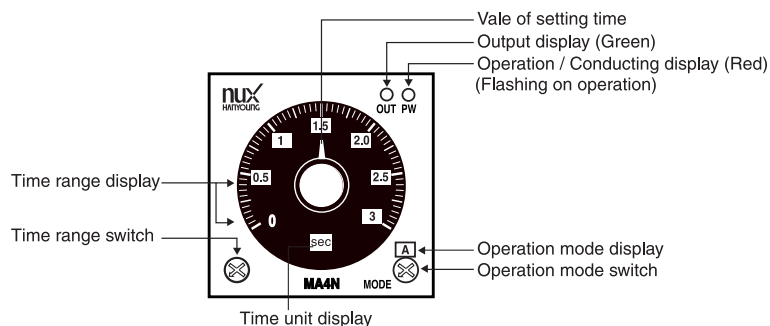

■ Selection of operation mode

Please select operation mode by turning of operation mode switch in front of panel. User can select 6 types of operation modes Operation mode is displayed as like A, B, C, D, E, F or A1, B1, C1, D1, E1, F1.

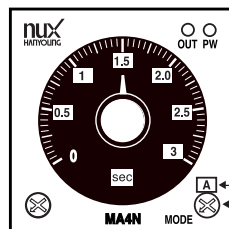

MA4N -A, MA4N - B TYPE

MODE	Function of operation
A	ON DELAY
B	FLICKER OFF START
C	INTERVAL
D	SIGNAL ON/OFF DELAY
E	SIGNAL OFF DELAY
F	FLICKER ON START

MA4N - C TYPE

MODE	Function of operation
A1	ON DELAY
B1	ON DELAY1
C1	ON DELAY2
D1	FLICKER OFF START
E1	FLICKER ON START
F1	INTERVAL

■ Selection of Time unit

Please select time by turning of Time range switch Use can select 16 types of time ranges and it is displayed as like sec, min, hrs, 10h

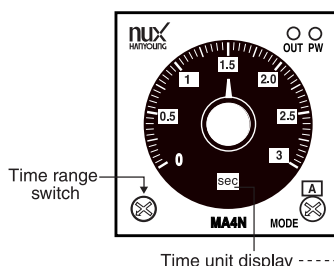

Time unit	Time range
sec, min, hrs, 10h	0, 0.2, 0.4, 0.6, 0.8, 1.0, 1.2
	0, 0.5, 1, 1.5, 2, 2.5, 3
	0, 2, 4, 6, 8, 10, 12
	0, 5, 10, 15, 20, 25, 30

Time range

Time unit		sec	min	hrs	×10h
Setting range	1.2	0.12 ~ 1.2			1.2 ~ 12
	3	0.3 ~ 3			3 ~ 30
	12	1.2 ~ 12			12 ~ 120
	30	3 ~ 30			30 ~ 300

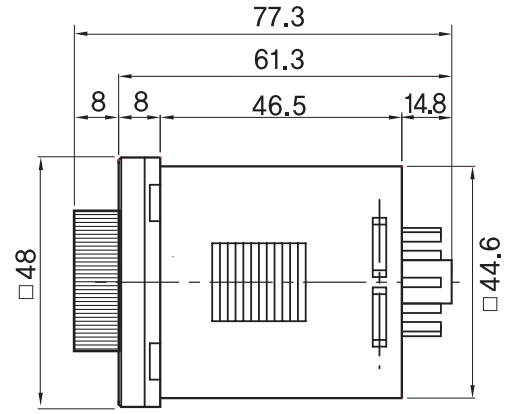

Specifications

Mode		MA4N-A	MA4N-B	MA4N-C
Supply voltage		24 - 240 V a.c./d.c 50 - 60 Hz		
Voltage regulation		±10% from supply voltage		
Power consumption		4.4 V A (240 V a.c), 2.1 W (240 V d.c)		
Resetting time		Max. 0.1 sec		
MinSignal length	START Input	Min. 20ms		-
	INHIBIT Input			
	RESET Input			
Input condition	START Input	Non voltage input Impedance in a short circuit: Max. 2 MΩ Residual voltage in a short circuit: Max. 0.7 V d.c Impedance in open: Min. 100 MΩ		
	INHIBIT Input			
	RESET Input			
Output	Time Limit contact 2c	Time Limit contact 1c	Time Limit 2c	
		Instantaneous contact 1c	Time Limit 1c	
			Instantaneous 1c	
		N.O: 10 A 125 V a.c, 5 A 250 V a.c, 5 A 30 V d.c		
		N.C: 3 A 125 V a.c, 2 A 250 V a.c, 1 A 30 V d.c		
Setting error		Max. ± 5 % ±0.05 sec		
Repeat error		Max. ± 0.3 %		
Temperature error		Max. ± 2 %		
Insulation resistance		Min. 100 MΩ (Base on 500 V d.c)		
Dielectric strength		2000 V a.c 50/60 Hz for 1 min.		
Impulse voltage		± 2000 V Max.		
Vibration	Mechanical durability	10-55Hz double amplitude 0.75mm		
	Malfunction durability	10-55Hz double amplitude 0.5mm		
Shock	Mechanical durability	300m/s ² (Approx. 30G)		
	Malfunction durability	100m/s ² (Approx. 10G)		
Life expectancy	Mechanical	Over 10 million operations (Open & Short frequency : 180/min)		
	Electrical	Over 100,000 (250V a.c 3A load resistance)		
Terminal type		Socket type 11 Pin	Socket type 8 Pin	
Operation ambient temperature		-10 ~ 55 °C (No condensation)		
Conservation temperature		-20 ~ 65 °C (No condensation)		
Operation ambient humidity		35 ~ 85 %RH		
Weight		About 100g (Including fixing bracket)		

Panel cutout

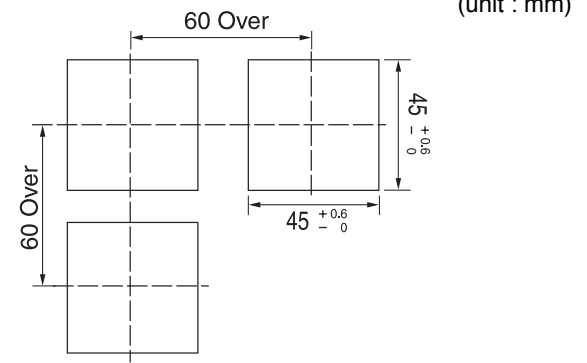

Connections

MA4N-A / MA4N-B

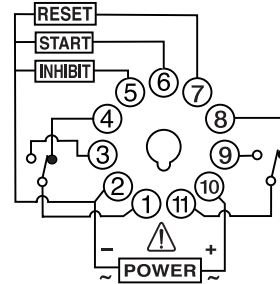

- MA4N-A : 2 relay work as Time limit.
- MA4N-B : The relay connected ①, ③, ④ work as Instantaneous and other relays work as time limit.
- ※ Please refer to Timing charts for working of relays

MA4N-C

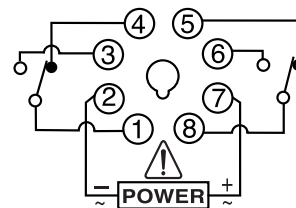

- Two relays in Mode A1 and D1 work as Time limit.
- The relays in Mode B1, C1, E1, F1 connected ①, ③, ④ work as Instantaneous. And other relays work as time limit.
- ※ MA4N-C : According to timing charts, relays work as Time limit or Instantaneous.
- ※ Please refer to Timing charts for working of relays.

Dimensions

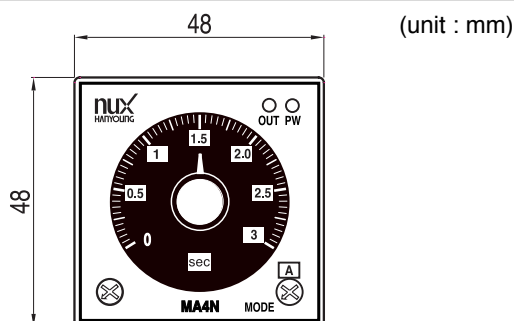

■ Timing charts (MA4N-A, MA4N-B)

※MA4N-A: OUTPUT – TIME LIMIT 2c MA4N-B: OUTPUT – Instantaneous 1C, Time limit 1c

A MODE: ON DELAY

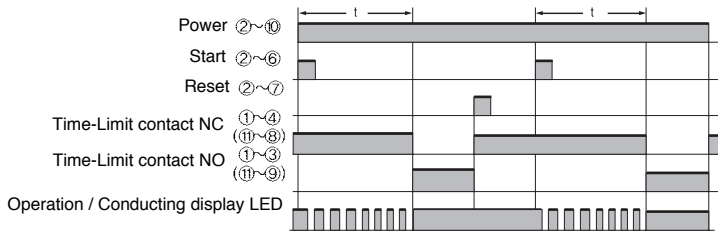

B MODE: FLICKER OFF START

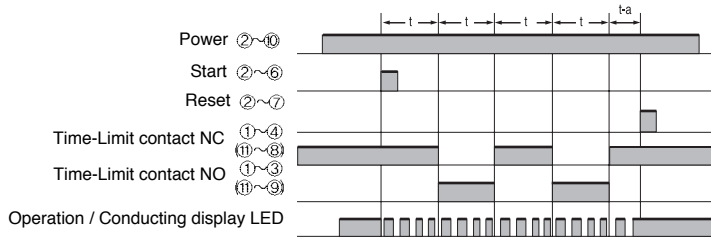

C MODE: INTERVAL

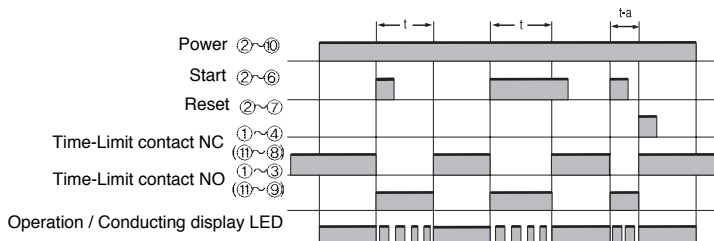

D MODE: Signal ON / OFF delay

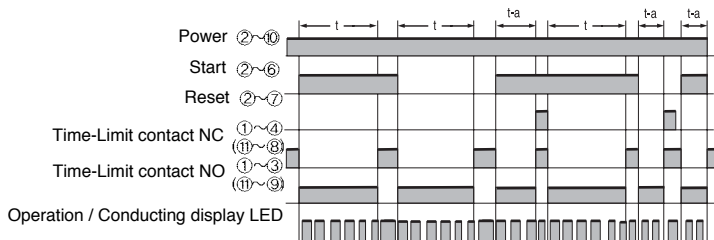

E MODE: Signal OFF delay

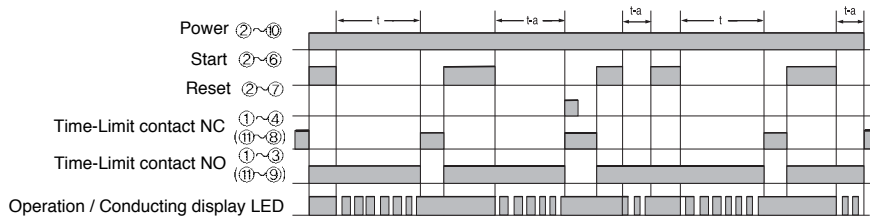

F MODE: FLICKER ON Start

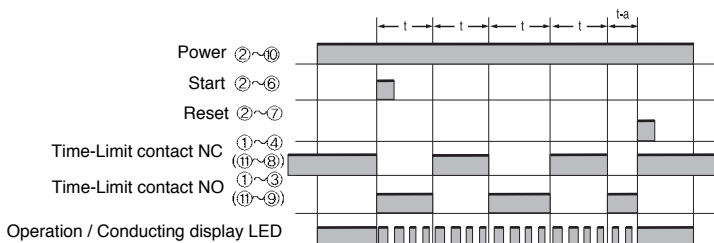

■ Timing charts (MA4N-C)

t: Setting time, t-a: Within setting time, Rt: Resetting time

A 1 MODE: ON DELAY

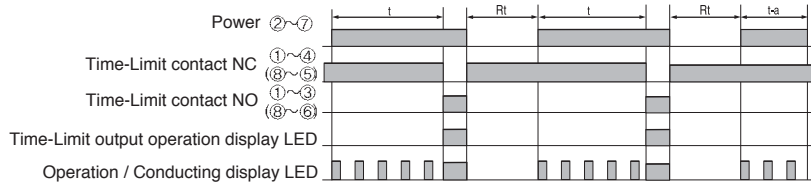

B1 MODE: ON DELAY 1 (One-shot output)

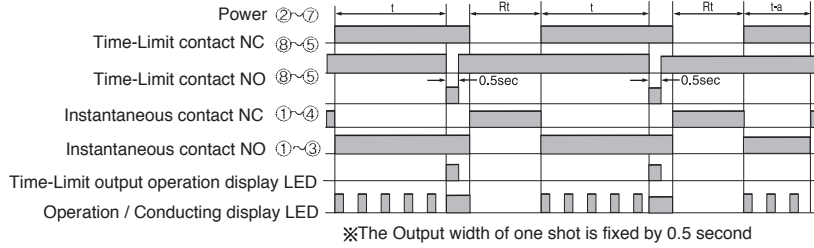

C1 MODE: ON DELAY2

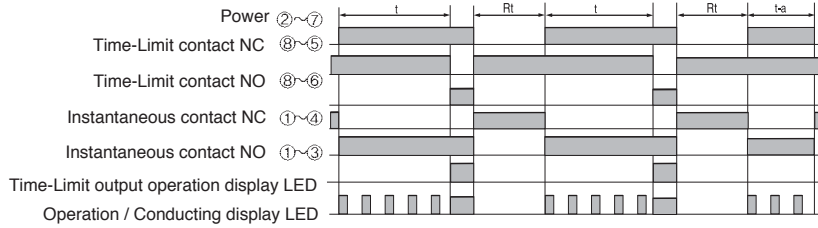

D1 MODE: FLICKER OFF START

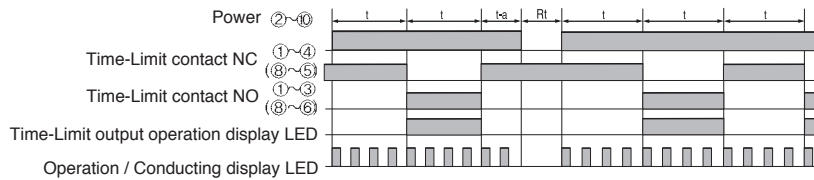

E1 MODE: FLICKER ON START

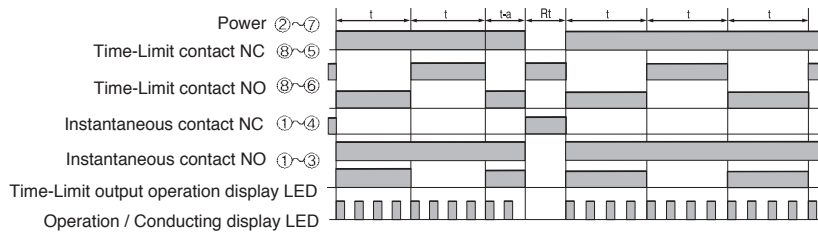

F1 MODE: INTERVAL

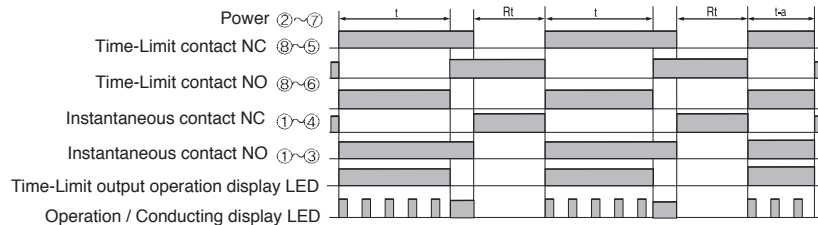

※ We suggest over 100ms of Min. setting time for D1, E1 output mode because excessive short setting time may cause of malfunction