

Digital Multi Panelmeter

HANYOUNG NUX

MP3/MP6

INSTRUCTION MANUAL

Thank you for purchasing HANYOUNG product.
Please check whether the product is the exactly same as you ordered.
Before using the product, please read this instruction manual carefully.
Please keep this manual where you can view at any time



HEAD OFFICE 1381-3, Juan-Dong, Nam-Gu Incheon, Korea
TEL: (82-32)876-4697 FAX: (82-32)876-4696

Safety information

Alerts declared in the manual are classified to Danger, Warning and Caution by their criticality

DANGER	DANGER indicates an imminently hazardous situation which, if not avoided, will result in death or serious injury
WARNING	WARNING indicates a potentially hazardous situation which, if not avoided, could result in death or serious injury
CAUTION	CAUTION indicates a potentially hazardous situation which, if not avoided, may result in minor or moderate injury

DANGER

There is a danger of occurring electric shock in the input/output terminals so please never let your body or conductive substance is touched.

WARNING

- This product does not contain an electric switch or fuse, so the user needs to install a separate electric switch or fuse externally. (Fuse rating: 250V 0.5A)
- To prevent deflection or malfunction of this product, supply proper power voltage in accordance with the rating.
- To prevent electric shock or malfunction of product, do not supply the power until the wiring is completed.
- Since this product is not designed with explosion-protective structure, do not use it any place with flammable or explosive gas.
- Do not decompose, modify, revise or repair this product. This may be a cause of malfunction, electric shock or fire.
- Reassemble this product while the power is OFF. Otherwise, it may be a cause of malfunction or electric shock.
- If you use the product with methods other than specified by the manufacturer, there may be bodily injuries or property damages.
- Due to the danger of electric shock, use this product installed onto a panel while an electric current is applied.

CAUTION

- The contents of this manual may be changed without prior notification.
- Before using the product you purchased, make sure that it is exactly what you ordered.
- Make sure that there is no damage or abnormality of the product during delivery.
- Do not use this product at any place with corrosive (especially noxious gas or ammonia) or flammable gas.
- Do not use this product at any place with direct vibration or impact.
- Do not use this product at any place with liquid, oil, medical substances, dust, salt or iron contents. (Use at Pollution level 1 or 2)
- Do not polish this product with substances such as alcohol or benzene.
- Do not use this product at any place with a large inductive difficulty or occurring static electricity or magnetic noise.
- Do not use this product at any place with possible thermal accumulation due to direct sunlight or heat radiation.
- Install this product at place under 2,000m in altitude.
- When the product gets wet, the inspection is essential because there is a danger of electric leakage or fire.
- If there is excessive noise from the power supply, using insulating transformer or noise filter is recommended. The noise filter must be attached to a panel which is already connected to a ground and the wire between the filter output and power supply terminal must be as short as possible.
- If putting power cables closely together then it is effective against noise.
- Do not connect anything to the unused terminals.
- After checking the polarity of terminal, connect wires at the correct position.
- When this product is connected to a panel, use a circuit breaker or switch approved with IEC947-1 or IEC947-3.
- Install the circuit breaker or switch at near place for convenient use.
- Write down on a label that if the circuit breaker or switch is operating then the power will be disconnected since the circuit breaker or switch is installed.
- For the continuous and safe use of this product, the periodical maintenance is recommended.
- Some parts of this product have limited life span, and others are changed by their usage.
- The warranty period for this product including parts is one year if this product is properly used.

Suffix Code

■ MP3

Model	Code	Description
MP3-	<input type="checkbox"/> <input type="checkbox"/> <input type="checkbox"/> <input type="checkbox"/> <input type="checkbox"/> <input type="checkbox"/>	Digital Multi Panelmeter 96 x 48 mm
Displayable Digit	4	4 digits (9999)
Input Specification	AV	a.c VOLTAGE
	AA	a.c AMPERE
	DV	d.c VOLTAGE
	DA	d.c AMPERE
	AVR	a.c VOLTAGE(RMS)
	AAR	a.c AMPERE(RMS)
Output (Option)	N	Display only
	0	Relay Output(HI,GO,LO) + Current Output (4 - 20 mA)
	1	Relay Output (HI, GO, LO)
	2	NPN Open Collector Output(HI,GO,LO), BCD Output(Dynamic)
	3	PNP Open Collector Output(HI,GO,LO), BCD Output(Dynamic)
	4	NPN Open Collector Output(HI,GO,LO), • Current Output(4 - 20 mA)
	5	PNP Open Collector Output(HI,GO,LO), • Current Output(4 - 20 mA)
	6	NPN Open Collector Output(HI,GO,LO), Serial Output(10speed)
	7	PNP Open Collector Output(HI,GO,LO), Serial Output(10speed)
	8	NPN Open Collector Output(HI,GO,LO), RS485 Output
	9	PNP Open Collector Output(HI,GO,LO), RS485 Output
	10	BCD Output(Static)
11	Relay Output (HI,GO,LO) +RS485 Front	
Front panel type	A	Front Acrylic type
	B	Front Plate type
Power supply voltage	•	None (100 - 240 V a.c 50 - 60 Hz)
	C	24 V d.c power supply (only for plastic type)

■ MP6

Model	Code	Description
MP6-	<input type="checkbox"/> <input type="checkbox"/> <input type="checkbox"/> <input type="checkbox"/> <input type="checkbox"/> <input type="checkbox"/>	Digital Multi Panelmeter 72 x 36 mm
Displayable Digit	4	4 digits (9999)
Input Specification	AV	a.c VOLTAGE
	AA	a.c AMPERE
	DV	d.c VOLTAGE
	DA	d.c AMPERE
	AVR	a.c VOLTAGE(RMS)
	AAR	a.c AMPERE(RMS)
Output (Option)	N	Display only
	0	Relay, present value output (4 - 20 mA d.c)
	1	Relay
	4	NPN Open Collector, present value output (4 - 20 mA)
	5	PNP Open Collector, present value output (4 - 20 mA)
Front panel type	A	Front Acrylic type
	B	Front Plate type (Recommended)
Power supply voltage	•	No indication (100 - 240 V a.c 50 - 60 Hz)
	C	24V dc (Front division B, only applied with the name plate attached type)

※Current Output about PV (present value)

※Output Specification, 0 ~ 11, is "OPTION."

※The specification of this manual may be changed without a prior notification due to its improvement

※When measuring a current higher than 5 A d.c, an exclusive shunt will be necessary so please choose "Type of DC Volt" when you are ordering.

※MP6-Communication output and BCD output are on the development

Specification

Power Supply	100 - 240 V a.c. 50 - 60 Hz allowable operating voltage range : 85 ~ 110 %
Power Consumption	5 VA
Display	7 segment LED Display
Insulation Resistance	100 M Ω min. (at 500 V d.c.) between external terminal and case
Dielectric Strength	2000 V a.c. min. for 1 minute between external terminal and case
Noise Immunity	By noise simulator, square-shaped wave noise, pulse width 1 μ s, \pm 1000 V
Vibration Resistance	Malfunction : 10 - 55 Hz Single amplitude 0.5 mm X · Y · Z each direction for 1 hour Durability : 10 - 55 Hz Single amplitude 0.75 mm X · Y · Z each direction for 2 hours
Shock Resistance	Malfunction : 100 m/s ² for 3 times each in X · Y · Z direction Durability : 300 m/s ² for 3 times each in X · Y · Z direction
Operating Ambient temperature	-10 ~ +55 °C (with no freezing)
Operating Ambient Humidity	Relative Humidity 35 ~ 85 % RH
Operating Circumstance	With no corrosive gas
Storage Ambient	-20 ~ 65 °C (with no freezing)
Temperature	Mechanical: 20,000,000 ps Min.
Relay Life Expectancy	Electrical: 100,000 ps Min.
Input Signal	DC Voltage/Current, AC Voltage/Current
Sampling Cycle	d.c type : 100 ms a.c type : 300 ms
Max. Displayable Digits	-1999 ~ 9999 (4 digits)
Scaling Function	Display function of converting to a value from measured and inputted Max./ Min. value
Hold Function	Max/Min Hold a value of detecting an automatic "peak"
External Control	Hold a displayed value
Other Functions	<ul style="list-style-type: none"> • Remote/Local Conversion (Communication Output type) • Display Max/Min value by front panel key • Protection function from changing a setting value • Average processing/displayed cycle delay function • Conversion of setting for Comparative Output • Auto zero function by front panel key
Types of Output	<ul style="list-style-type: none"> • Relay Output (contact point: 3 outputs) • Low speed serial output • BCD Output (Static, Dynamic) • Transistor Output (NPN, PNP) • Current Output (4 - 20 mA) • Communication Output (RS485)
Weight	Approx. 180 g

Wiring Diagram

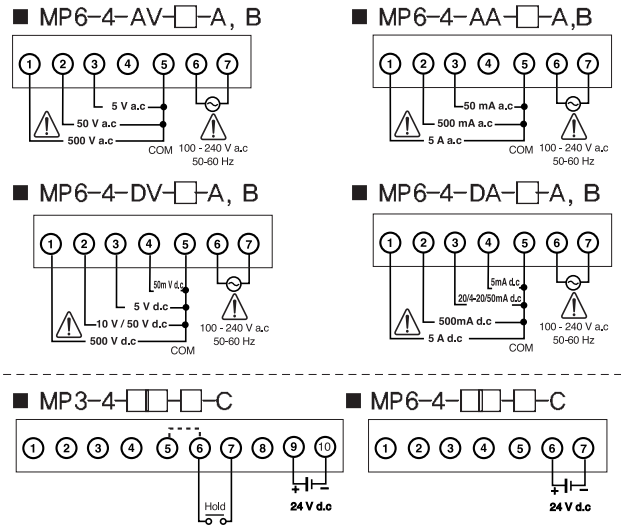
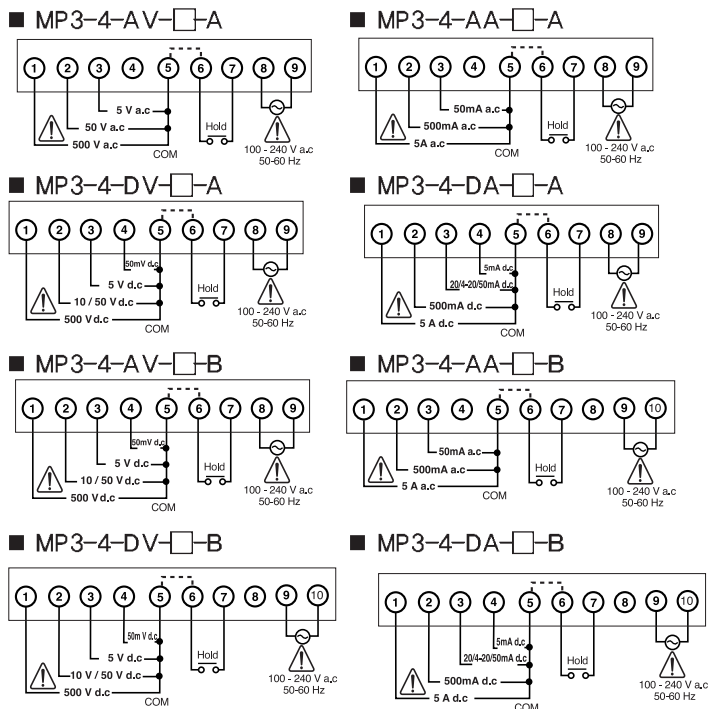

※C type : 24 V d.c power supply.

Pin arrangements are same as other models.

※Attention : When you use MP6 optional product (except only display product), number 5 and number 6 (B Type is number 12) are shorted internally so you need to draw attention.

Auxiliary Output

- BCD Dynamic Output
Hirose 20P Flat Connector
NPN open collector
12 - 24 V d.c 50 mA Max.
(MP3 A, B Type)

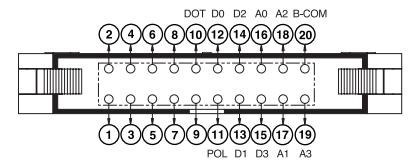

- BCD Static Output
Hirose 20P Flat Connector
NPN open collector
12 - 24 V d.c 50 mA Max.
(MP3 A, B Type)

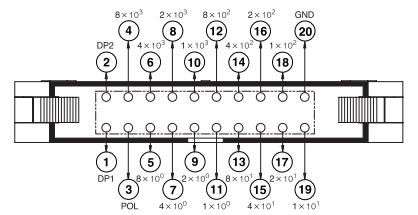

- Terminal Arrangement of Low Speed Serial Output Specification
Hirose 20P Flat Connector
NPN open collector
12 - 24 V d.c 50 mA Max.
(MP3 A, B Type)

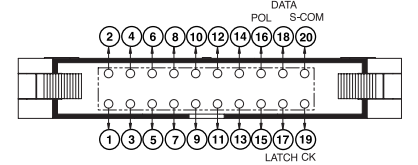

- Terminal Arrangement of RS485 Output Specification
Hirose 20P Flat Connector
(MP3 A, B Type)

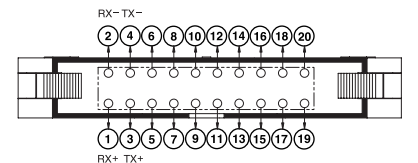

- Terminal Arrangement of Current Output Specification
Hirose 20P Flat Connector
(MP3 A, B Type)

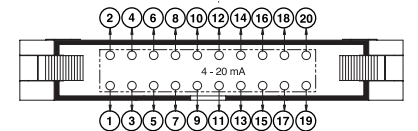

- MP3-4-□□□-0-A
(Relay Output + Current Output 4 - 20 mA)

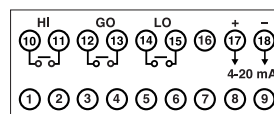

- MP3-4-□□□-1-A
(Relay Output)

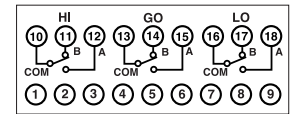

- MP3-4-□□□-11-A
(Relay Output + RS485 Output)

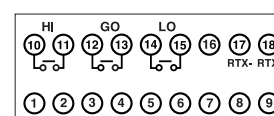

- MP3-4-□□□-0-B
(Relay Output + Current Output 4 - 20 mA)

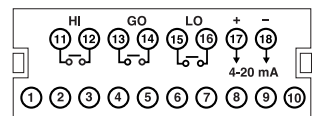

Measuring Input Specification

TYPE	MODE	Max. Measuring Range	Standard Display Range	Input Impedance	Accuracy	Max. Scale Display Range
DC Voltage	005H	50 mV	0 ~ 50.00	25 kΩ	Below ±2 Digit	-1999 ~ 1999
	5H	5 V	0 ~ 5.000	100 kΩ		
	10H	10 V	0 ~ 10.00	1 MΩ		
	50H	50 V	0 ~ 50.00	1 MΩ		
DC Current	5nA	5 mA	0 ~ 5.000	10 Ω	Below ±5 Digit	-19.99 ~ 199.9
	20nA	20 mA	0 ~ 20.00	1 Ω		
	4-20	20 mA	4 ~ 20.00	1 Ω		
	50nA	50 mA	0 ~ 50.00	1 Ω		
	05A	500 mA	0 ~ 500.0	0.1 Ω		
AC Voltage	5H	5 V	0 ~ 5.000	100 kΩ	Below ±5 Digit	The display range will be varied with the setting of decimal point position.
	50H	50 V	0 ~ 50.00	1 MΩ		
	500H	500 V	0 ~ 500.0	10 MΩ		
AC Current	60nA	60 mA	0 ~ 60.00	1 Ω		
	06A	600 mA	0 ~ 600.0	0.1 Ω		
	5A	5 A	0 ~ 5.000	0.01 Ω		

Factory Default

PARAMETER	MODE	MP3-DV	MP3-DA	MP3-AV	MP3-AA
PARAMETER 1	LIrS	500H	5A	500H	5A
	2HdP	1000	1000	1000	1000
	3LdP	0	0	0	0
	4Rdt	0.2	0.2	0.5	0.5
	5Pdd	0	0	0	0
	6SCH	0	0	0	0
	7SCL	0	0	0	0
	8dPP	0000	0000	0000	0000
	9PdH	oFF	oFF	oFF	oFF
	RLoC	oFF	oFF	oFF	oFF
	bRdr	00	00	00	00
	dbPS	9.6E	9.6E	9.6E	9.6E
	PARAMETER 2	hHPV	-	-	-
lLPV		-	-	-	-
HSEt		5000	5000	5000	5000
LSEt		2000	2000	2000	2000
PSoE		oFF	oFF	oFF	oFF
	HYS	01	01	01	01

* By the specification, *Rdr* and *bPS* may not be displayed.

Parameter 1 Terminology Explanation

- LIrS**: Set a range of input specification of desired to be measured.
- 2HdP**: Use a function of desiring to multiply an input measured value.
- 3LdP**: Correct an error by adding/subtracting to an input measured value. Ex) If you want to display 5000 but the measured value is 5010, then set -10 in *LdP* parameter. The displayed value will be 5000. Default = 0
- 4Rdt**: It is difficult to measure an accurate value in a place of where an input measured value is varying too much. In this event, it is possible to display it as an averaged value by changing the cycle of the setting value. Ex) If set 2.0 in *Rdt* parameter then it will be displayed an averaged value by every 2 seconds after taking the values for 2 seconds. Default = 0.2 Sec.
- 5Pdd**: In an event of detecting max/min value, there is a possibility of detecting an erroneous value by an effect of the initial overvoltage and overcurrent. To prevent this matter, set delay time of detecting. Ex) If set 5 in *Pdd* parameter after connecting power source then it will detect max/min value after 5 seconds. When changing a setting value during an operating it will not affect detecting the present max/min value. Default = 0
- 6SCH**: Function which sets a higher limit of input (measured) value. (*SCH* = display value A or B) SCALE function, Default = 0
- 7SCL**: Function which sets a lower limit of input (measured) value. (*SCL* = display value B or A) SCALE function, Default = 0

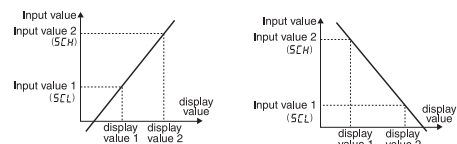

Built scale function, which can convert input signals into other values is available. Rising, reversing and + ~ - display can be adjusted freely.

MP3-4-□-1-B (Relay Output)

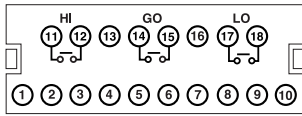

MP3-4-□-11-B (Relay Output + RS485 Output)

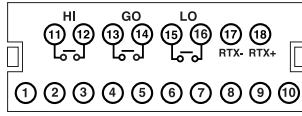

MP6-4-□-0-A (Relay Output + Current Output 4 - 20 mA)

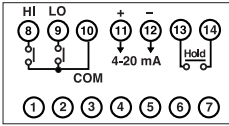

MP6-4-□-1-A (Relay Output)

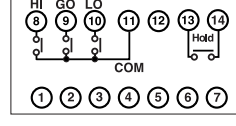

MP6-4-□-2-A (NPN TR Output)

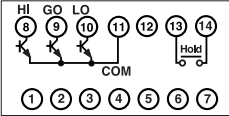

MP6-4-□-3-A (PNP TR Output)

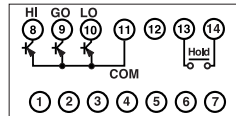

MP6-4-□-4-A (Relay Output + RS485 Output)

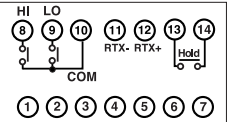

MP6-4-□-0-B (Relay Output + Current Output 4 - 20 mA)

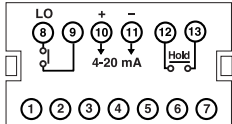

MP6-4-□-1-B (Relay Output)

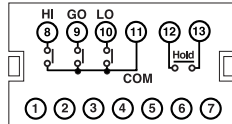

MP6-4-□-2-B (NPN TR Output)

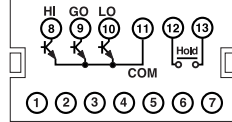

MP6-4-□-3-B (PNP TR Output)

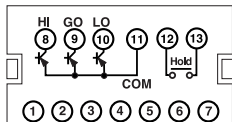

MP6-4-□-4-B (NPN TR Output)

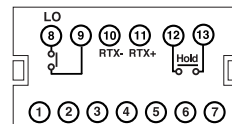

Main Output

Terminal Arrangement of TR[NPN] Output Specification Output Specification Hirose 20P Flat Connector

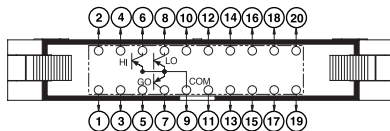

Terminal Arrangement of TR[NPN] Output Specification Output Specification Hirose 20P Flat Connector

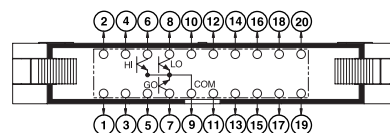

Input signal	Scale setup		Display value
	SCL	SCH	
0 ~ 10 V d.c Input Input value1 : 0 V Input value2 : 10 V	0	0	0 ~ 10.00 (default value is displayed)
	0	1800	0 ~ 1800
	1800	0	1800 ~ 0
	-1000	5000	-1000 ~ 5000
	5000	-1000	5000 ~ -1000
	1000	6000	1000 ~ 6000
	6000	1000	6000 ~ 1000
4 ~ 20 mA d.c Input Input value1 : 0 V Input value2 : 10 V	0	200	0 ~ 200
	200	0	200 ~ 0
	-1000	200	-1000 ~ 200
	200	-1000	200 ~ -1000

BdPP : Set a position of a decimal point. Default=000.0

SPdH : When detecting a peak value, you can use an automatic holding **PDH** function. Default=OFF. Ex) if you choose H-Hd (Holding max value) in parameter then it will display max value among the input measured values, including the present value when the present value is less than the max value. In contrast, if the present value is higher than the max value then it will be displayed the present value by the automatic hold. The way of operating L-Hd hold (holding min value) is the same as the way of H-Hd hold (holding max value) does.

RLoC : This function is used to lock the parameter function of the panel meter. Ex) if **LoC** parameter sets to be ON then it is impossible to set any parameters at this time.

bAdr : Set Communication Address. Default=00

CbPS : Set Baud Rate. Default=9600 bps

Parameter 2 Terminology Explanation

HHPV : Display max value among measured values of inputs.

LLPV : Display min value among measured values of inputs.

HSEt : Set a value of High Comparative Output. Default=5000

LSEt : Set a value of Low Comparative Output. Default=0

PSot : Select an operating mode of Comparative Output. Default=OFF

HYS : Set hysteresis of Comparative Output. Default=01

Comparative Output Mode (PSot)

Display	Output Operation	Explanation
	<p>H : Hysteresis</p>	
oFF		No comparative output operation
LLot		If $PDV \geq LSEt$ then Low Output ON. If $PDV > HSEt$ then Go Output ON.
HHot		If $PDV \leq HSEt$ then High Output ON. If $PDV < LSEt$ then Go Output ON.
LHot		If $PDV \geq LSEt$ then LOW Output ON. If $PDV \leq HSEt$ then High Output ON. If $PDV \leq LSEt$ or if $PDV < HSEt$ Then Go Output ON.
HLot		If $PDV \geq LSEt$ then LOW Output ON. If $PDV \leq HSEt$ then High Output ON. If $PDV \leq LSEt$ or if $PDV < HSEt$ Then Go Output ON.
ILot		It's the same as LLot Function. But low output will not operate under the initial setup value of LSEt . From the next value under LSEt low output will operate.

It does not operate under the initial **LSEt**

Parameter 1

Display	Meaning	Initial Setting	Setting Range	Note	
LIrS	Input range Set	DV Spec. 500H	0	005H	Choose a measuring range of an input specification
			1	5H	
			2	10H	
			3	50H	
		DA Spec. 5A	0	5nA	
			1	20nA	
			2	4-20	
			3	50nA	
			4	05A	
		AV Spec. 500H	0	5H	
			1	50H	
			2	500H	
AA Spec. 5A	0	50nA			
	1	05A			
		2	5A		
2HdP	Mul or Div	1000	Max. Set Value : 1800 Min. Set Value : 0.500	(Scale Factor)	
3LdP	diff Proof-reading	0	Max. Set Value : 99 Min. Set Value : -99	Correct an error	
4Adt	Average delay time	0.2	Max. Set Value : 5.0 Min. Set Value : 0.1	Set a time to measure an average input value	
5PdD	Peak detect delay time	0	Max. Set Value : 30 Min. Set Value : 0	Set a delay time to detect a peak value	
6SCH	High Scale	0	Max. Set Value : 9999 Min. Set Value : -9999	Set a higher limit of input (measuring) value	
7SCL	Low Scale	0	Max. Set Value : 9999 Min. Set Value : -9999	Set a lower limit of input (measuring) value	
BdPP	Dot Point	0000		Set a position of a decimal point	
9PdH	Peak auto detect Hold	oFF	oFF	Set an automatic holding when detecting a peak value	
			H-Hd	External Hold (E-Hd)	
			L-Hd	External Hold (E-Hd)	
RLoC	Lock	oFF	oN	Set a lock function of a panel meter	
			oFF		
bAdr	Address	oFF	Max. Set Value : 99 Min. Set Value : 00	Set Communication ADDRESS or baud rate (BPS)	
CbPS	bps	96H	12H	1200	
			24H	2400	
			48H	4800	
			96H	9600	
			192H	19200	
			384H	38400	

Parameter 2

Display	Meaning	Initial Setting	Setting Range	Note
HHPV	High Peak Display	-	No Setting	Display max value among present input values.
LLPV	Low Peak Display	-	No Setting	Display min value among present input values.
HSEt	Output High Set	5000	Max. Set Value : +9999 Min. Set Value : -1999	Set a standard value of High Comparative Output.
LSEt	Output Low Set	2000	Max. Set Value : +9999 Min. Set Value : -1999	Set a standard value of Low Comparative Output.
PSot	Output Type Select	oFF	LL(LLot)	Set a mode of Comparative Output Operation.
			HH(HHot)	
			LH(LHot)	
			HL(HLot)	
HYS	Hysteresis	01	Max. Set Value : 99 Min. Set Value : 00	Set hysteresis of Comparative Output.

Parameter Setting Method

Parameter 1 (* key – more than 2 seconds)

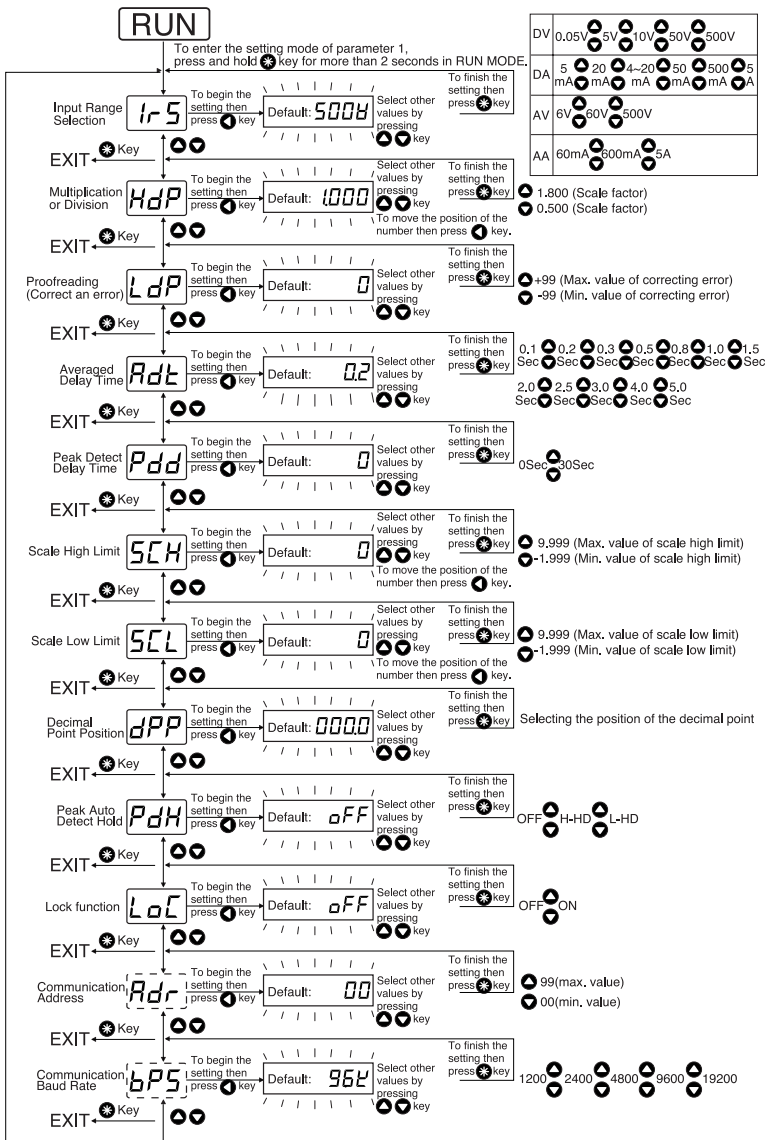

BCD Static Output (Auxiliary Logic)

Wiring diagram

PIN NO.	Signal	PIN NO.	Signal
1	DP1	11	1 × 10 ⁰
2	DP2	12	8 × 10 ⁰
3	POL	13	8 × 10 ¹
4	8 × 10 ⁰	14	4 × 10 ⁰
5	8 × 10 ¹	15	4 × 10 ¹
6	4 × 10 ⁰	16	2 × 10 ⁰
7	4 × 10 ¹	17	2 × 10 ¹
8	2 × 10 ⁰	18	1 × 10 ⁰
9	2 × 10 ¹	19	1 × 10 ¹
10	1 × 10 ⁰	20	GND

Decimal Point

DP2	DP1	
0	0	10 ⁰
0	1	10 ¹
1	0	10 ⁰
1	1	10 ¹

POL : Polarity
DPX : Decimal point

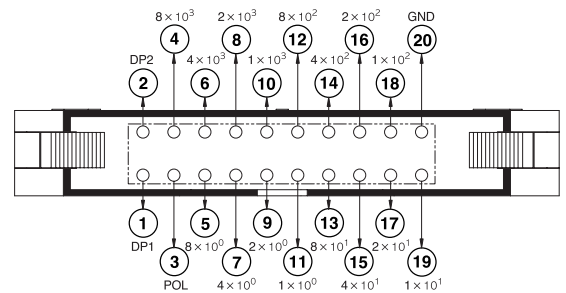

BCD Dynamic Output (Auxiliary Logic)

T : 8 ms (minimum)
td : 0.05 ms (minimum)
th : 7.9 ms (minimum)

POL : Polarity
DOT : Decimal Point
B-COM : BCD Common

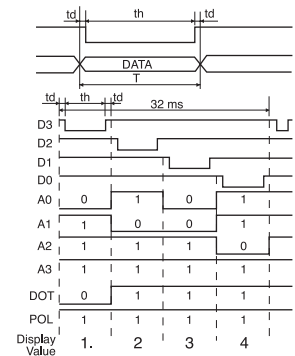

Low Speed Serial Output (Auxiliary Logic)

ta : 0.05 ms (minimum)
td : 200.5 ms (minimum)
tr : 9.9 ms (minimum)
t : 20 ms (minimum)

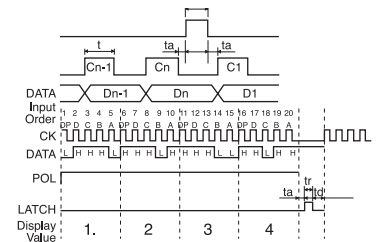

Lock Key (* Key – for more than 2 seconds)

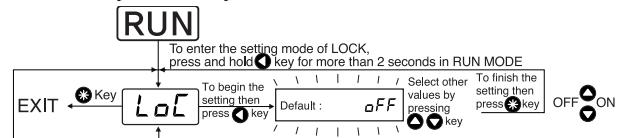

※ When **LoL** function is ON, it is impossible to set any of parameters.

Parameter 2 (* key – less than 2 seconds)

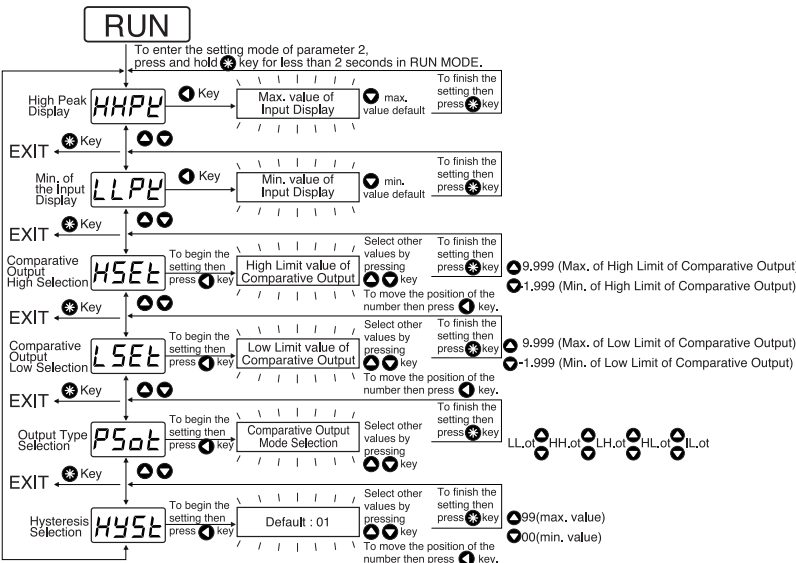

How to change Setting of Parameters

1. In RUN MODE, press **⌘** for more than 2 seconds to enter Parameter 1 setting mode or for less than 2 seconds to enter Parameter 2.
2. By using **▲**, **▼** keys, you can see one of the parameters in each parameter 1 or 2. If you are at one of the parameters, the parameter and set value is flickering repeatedly in the display.
3. By using **◀** key, you can begin with changing a setting value in the chosen parameter. Only the setting value in the chosen parameter is flickering after pressing key. (When the default is 0, the number is flickering with only 0th digit.)

Ex) **HdP** → Default value: **1000** → setting then press **◀** key → Default: **1000** → Select other values by pressing **▲**/**▼** key

When the set number is 0, the number is flickering with only 0th digit.

To change 100th digit, press **◀** key for 3 times. Each time you press **◀** key then the position of digit will move to the left side by one. The chosen placed digit is flickering.

When the set number is 0, the number is flickering with only 0th digit.

By pressing **⌘** key, you can go back to parameter mode if you are done with the setting. Again, the parameter and the set value are flickering repeatedly. To go back to RUN MODE, you need to press **⌘** key.

How to Set Slope

If you want to display 3600 (min ~1999 ~ 9999) then the model specification should be MP3-4-DV-X and an input should be 10V. The way of changing the parameter setting is written the below (Follow the steps 1 ~ 4).

1. By pressing **⌘** key for more than 2 seconds, enter Parameter 1 mode.
2. In **IrS** (Input Range) parameter, set **10H** range mode.
3. In **SCH** (scale high limit) parameter, set **3600** by using shift, up and down keys.
4. In **SCL** (scale low limit) parameter, set **0** by using shift, up and down keys. Set the above and press Menu key again to go back to RUN MODE.

PARAMETER 1			
Parameter	IrS	SCH	SCL
Set Value	10H	3600	0

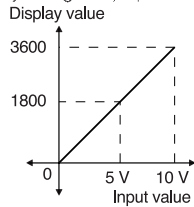

Defaulting Set Values

While pressing **▲** key, press the key **⌘** → **◀** → **▼** then **EESE** will be displayed. At that time, press **▲** key again then all the set values will be defaulted. (※ If **LoCE** function is ON, it is impossible to be defaulted)

Error Display Code

-HH-	: This will be displayed when it is higher than Max Range 9999 (for 4 digits model) or a negative number is appeared in Normal mode. Normal mode: SCH 0 or SCL 0
OBEr	: This will be displayed when a measured input value is over max input range.
HLEr	: A setting error will be displayed when a setting value of High Comparative Output is less than that of Low Comparative Output.

Retransmission Function (Auxiliary Output)

- RS485 Communication
 - By assigning Address from 00 to 99 and by selecting modulation speed of Serial Transmission it is possible to transmit.
 - Retransmission Speed (BPS) Selection Setting: (1200, 2400, 4800, 9600, 19200, 38400)
- Serial Communication
 - Having a present displayed value generates signals of POL (polarity), DOT (decimal point), CK (CLOCK), DATA and LATCH in order to be easily done with connecting PLC and other processors.
- Current Output
 - Generate 4 ~ 20 mA d.c for a present displayed value. (resolution 4.096)
- BCD Output
 - Generate a present displayed value as BCD type (D0, D1, D2, D3, POL (polarity) DOT (decimal point), A0, A1, A2, A3)
- PNP Output (Open Collector Output 12 ~ 24 V d.c below 50 mA)
- NPN Output (Open Collector Output 12 ~ 24 V d.c below 50 mA)
- RELAY Output (250 V a.c below 5A) 1a, 1b×3

Auto Zero function

In the RUN mode, Press **▲** + **▼** buttons to display **Auto** press **⌘**, **▼** buttons to run Auto-Zero function. Instead of 0 value, the different value is displayed due to input source err, Auto Zero function adjusts 0 value automatically.

Dimension & Panel cutout

Unit : mm

MP3

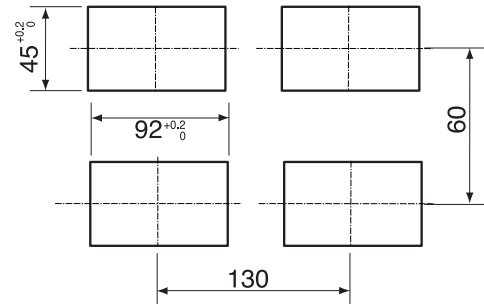
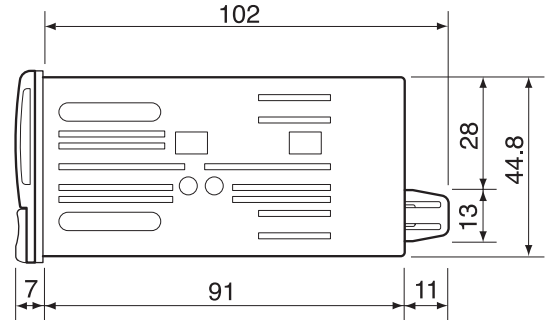
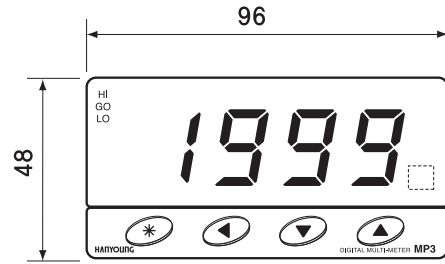

MP6

